

Inscription label holders ASCF

Technical data

Inscription label holder VMPA1, CPX, CPVSC1-ST, CPV

Inscription label holders enable inscription labels to be attached to components without pre-assembled carriers, or with special carriers for holders of this type.

If display components are concealed by the inscription label holder, the carrier is either semi-transparent or completely transparent.



Note

Microsoft Word templates for inscription label holders/ identification strips can be found at:
→ www.festo.com

Materials					
Type	VMPA1-ST-1	VMPA1-ST-2	CPX	CPVSC1-ST	CPV
Inscription label holder	PP	POM	PP	PVC	PVC

Inscription label holders ASCF

Technical data

Examples illustrating the attachment of inscription label holders

VMPA1-ST-...

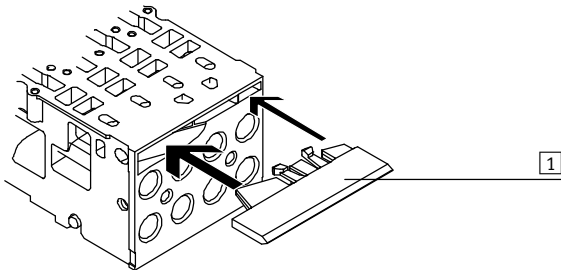

1 Inscription label holder VMPA1-ST...

- The inscription label holder is snapped into recesses on the valve terminal
- The inscription is created by inserting identification strips

CPVSC1-ST...

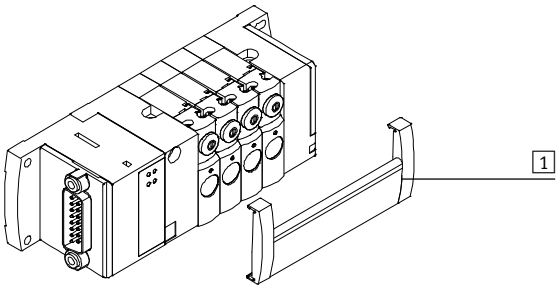

1 Inscription label holder CPVSC1-ST...

- The inscription label holder is clipped onto the valve terminal
- The inscription is created by inserting identification strips

CPV10-VI-...

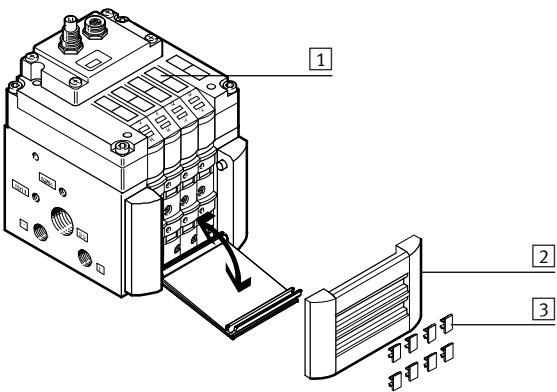

1 Inscription labels IBS-9x20
2 Inscription label holder CPV10-VI-BZT...
3 Inscription labels IBS-6x10

- The inscription label holder is snapped into recesses on the valve terminal
- The inscription is created using inscription labels or by inserting identification strips

-  - Note

The inscription label holder cannot be used together with relay slices.

Inscription label holders ASCF

Technical data

FESTO

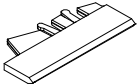
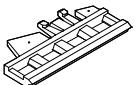
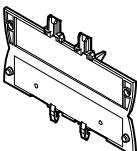
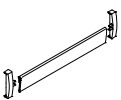
Ordering data						
	Carriers for inscription labels	Use	For modules with the following number of valves	Weight	Part No.	Type
				[g]		
	Insertable label or paper/ cardboard strips	Valve terminal MPA	–	6	533362	VMPA1-ST-1-4
	IBS-6x10 (4 pieces)	Valve terminal MPA	–	8	544384	VMPA1-ST-2-4
	Insertable label or paper/ cardboard strips	Modular electrical terminal CPX	–	5	536593	CPX-ST-1
	Insertable label or paper/ cardboard strips	Valve terminal CPV-SC	2	5	547395	CPVSC1-ST-2
			3	6	547396	CPVSC1-ST-3
			4	7	527631	CPVSC1-ST-4
			5	7	547397	CPVSC1-ST-5
			6	8	547398	CPVSC1-ST-6
			7	8	547399	CPVSC1-ST-7
			8	9	527633	CPVSC1-ST-8
			9	10	547400	CPVSC1-ST-9
			10	12	547401	CPVSC1-ST-10
			11	13	547402	CPVSC1-ST-11
			12	15	527635	CPVSC1-ST-12
			13	16	547403	CPVSC1-ST-13
			14	17	547404	CPVSC1-ST-14
15	18	547405	CPVSC1-ST-15			
16	20	527637	CPVSC1-ST-16			

Inscription label holders ASCF

Technical data

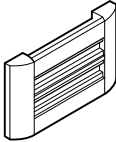
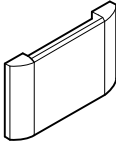
Ordering data						
	Carriers for inscription labels	Use	For modules with the following number of valves	Weight	Part No.	Type
				[g]		
	IBS-6x10 (4 pieces)	Valve terminal CPV in size 10	2	9	162560	CPV10-VI-BZ-T-2
	IBS-6x10 (6 pieces)		3	10	162561	CPV10-VI-BZ-T-3
	IBS-6x10 (8 pieces)		4	11	162562	CPV10-VI-BZ-T-4
	IBS-6x10 (10 pieces)		5	15	162563	CPV10-VI-BZ-T-5
	IBS-6x10 (12 pieces)		6	14	162564	CPV10-VI-BZ-T-6
	IBS-6x10 (14 pieces)		7	15	162565	CPV10-VI-BZ-T-7
	IBS-6x10 (16 pieces)		8	16	162566	CPV10-VI-BZ-T-8
	IBS-6x10 (4 pieces)		Valve terminal CPV in size 14	2	10	162567
	IBS-6x10 (6 pieces)	3		11	162568	CPV14-VI-BZ-T-3
	IBS-6x10 (8 pieces)	4		13	162569	CPV14-VI-BZ-T-4
	IBS-6x10 (10 pieces)	5		15	162570	CPV14-VI-BZ-T-5
	IBS-6x10 (12 pieces)	6		16	162571	CPV14-VI-BZ-T-6
	IBS-6x10 (14 pieces)	7		19	162572	CPV14-VI-BZ-T-7
	IBS-6x10 (16 pieces)	8		21	162573	CPV14-VI-BZ-T-8
	IBS-6x10 (4 pieces)	Valve terminal CPV in size 18		2	11	163293
	IBS-6x10 (6 pieces)		3	12	163294	CPV18-VI-BZ-T-3
IBS-6x10 (8 pieces)	4		17	163295	CPV18-VI-BZ-T-4	
IBS-6x10 (10 pieces)	5		18	163296	CPV18-VI-BZ-T-5	
IBS-6x10 (12 pieces)	6		20	163297	CPV18-VI-BZ-T-6	
IBS-6x10 (14 pieces)	7		23	163298	CPV18-VI-BZ-T-7	
IBS-6x10 (16 pieces)	8		29	163299	CPV18-VI-BZ-T-8	
	Insertable label or paper/ cardboard strips		Valve terminal CPV in size 10	2	8	194066
		3		10	194067	CPV10-VI-ST-3
		4		11	194068	CPV10-VI-ST-4
		5		13	194069	CPV10-VI-ST-5
		6		14	194070	CPV10-VI-ST-6
		7		15	194071	CPV10-VI-ST-7
		8		16	194072	CPV10-VI-ST-8
		Valve terminal CPV in size 14		2	10	194073
			3	11	194074	CPV14-VI-ST-3
			4	14	194075	CPV14-VI-ST-4
			5	15	194076	CPV14-VI-ST-5
			6	20	194077	CPV14-VI-ST-6
			7	19	194078	CPV14-VI-ST-7
			8	22	194079	CPV14-VI-ST-8
			Valve terminal CPV in size 18	2	11	194080
		3		13	194081	CPV18-VI-ST-3
		4		15	194082	CPV18-VI-ST-4
		5		18	194083	CPV18-VI-ST-5
		6		21	194084	CPV18-VI-ST-6
		7		23	194085	CPV18-VI-ST-7
		8		28	194086	CPV18-VI-ST-8

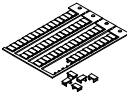
Ordering data – Accessories			
	Description	Part No.	Type
	Inscription labels 6x10 mm, 64 pieces, in frames	18576	IBS-6x10
	Inscription labels 9x17 mm, 24 pieces, in frames	161937	IBS-9x17
	Inscription labels 9x20 mm, 20 pieces, in frames	18182	IBS-9x20

Festo North America

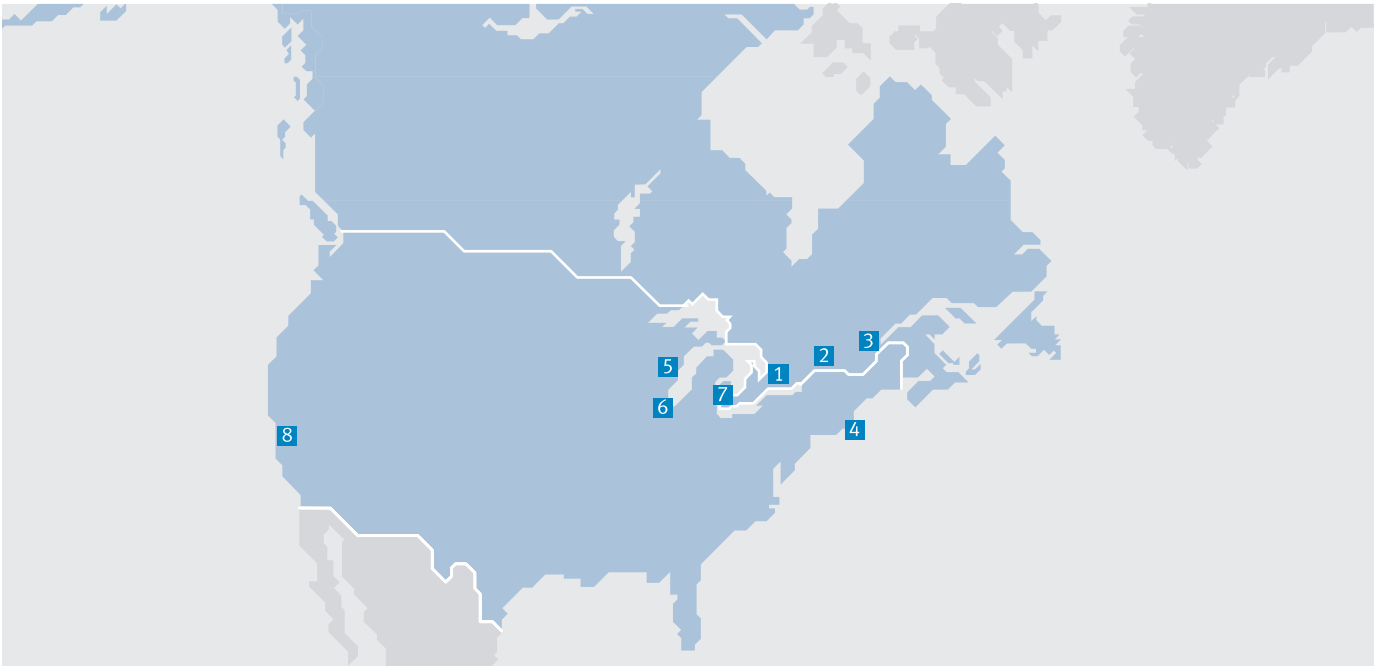

**1 Festo Canada
Headquarters
Festo Inc.**
5300 Explorer Drive
Mississauga, ON
L4W 5G4

2 Montréal
5600, Trans-Canada
Pointe-Claire, QC
H9R 1B6

3 Québec City
2930, rue Watt#117
Québec, QC
G1X 4G3



**4 Festo United States
Headquarters
Festo Corporation**
395 Moreland Road
Hauppauge, NY
11788

5 Appleton
North 922 Tower View Drive, Suite N
Greenville, WI
54942

7 Detroit
1441 West Long Lake Road
Troy, MI
48098

6 Chicago
85 W Algonquin - Suite 340
Arlington Heights, IL
60005

8 Silicon Valley
4935 Southfront Road, Suite F
Livermore, CA
94550

Festo Regional Contact Center

Canadian Customers

Commercial Support:
Tel: 1 877 GO FESTO (1 877 463 3786)
Fax: 1 877 FX FESTO (1 877 393 3786)
Email: festo.canada@ca.festo.com

Technical Support:
Tel: 1 866 GO FESTO (1 866 463 3786)
Fax: 1 877 FX FESTO (1 877 393 3786)
Email: technical.support@ca.festo.com

USA Customers

Commercial Support:
Tel: 1 800 99 FESTO (1 800 993 3786)
Fax: 1 800 96 FESTO (1 800 963 3786)
Email: customer.service@us.festo.com

Technical Support:
Tel: 1 866 GO FESTO (1 866 463 3786)
Fax: 1 800 96 FESTO (1 800 963 3786)
Email: product.support@us.festo.com