

Control blocks CPX-CEC



Control blocks CPX-CEC

Key features



Application Controller

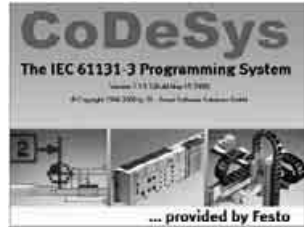

The CODESYS controllers are modern control systems for CPX terminals that enable programming with CODESYS to IEC 61131-3.

Programming in a global language

CODESYS provided by Festo offers a convenient user interface with the following functions:

- Integrated module libraries
- Library Manager for integrating further libraries
- Visualisation editor

- Simulation mode
- Integrated project documentation
- Debugging functions for fault finding
- Configuration and parameterisation of the controller using the control configuration

Basic functions

The CODESYS controllers offer the following basic functions:

- Programming with CODESYS to IEC 61131-3
- Communication via Ethernet (Modbus/TCP, EasyIP, TCP/IP)
- Process visualisation using operator unit CDPX or OPC server

- Communication via fieldbus in combination with a fieldbus node in the CPX terminal
- Diagnostics and quick commissioning of CPX modules via handheld CPX-MMI

CPX-CEC-C1 offers

- All basic functions
- CANopen master for controlling up to 127 CANopen stations. Electric axes can be controlled in point-to-point mode

CPX-CEC offers

- All basic functions
- RS232 interface for operating external devices

Note
When using external devices, data communication must be programmed by the user.

Bus connection

The CODESYS controllers are remote controllers that can be connected to a higher-order PLC via the fieldbus nodes of the CPX terminal or via Ethernet, for example:

- PROFINET
- EtherNet/IP
- EtherCAT
- PROFIBUS
- DeviceNet

Operating modes

- Stand-alone
- Remote controller on the fieldbus
- Remote controller on Ethernet

System expansion

CANopen connects CPX-CEC with valve terminals and electric drive controllers from Festo:

- CPX, CPV
- CMMP-AS, CMMS-ST, etc.
- AS-Interface gateway

Ethernet connects CPX-CEC with additional controllers and operator units from Festo:

- CECX
- CDPX
- Camera SBO...-Q

System expansion (examples)

CPX-CEC/CPX-CEC as a stand-alone or remote controller

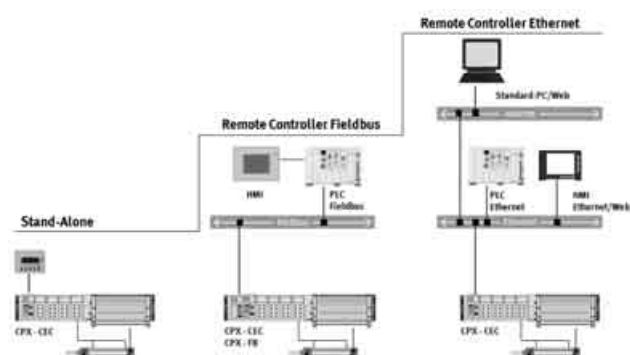

CPX-CEC-C1 as a CANopen fieldbus master

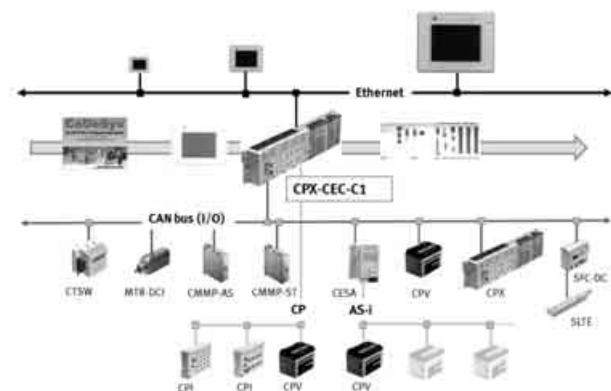

Control blocks CPX-CEC

Key features

Advantages for users			
Increased performance		Reduced costs	
Improved cycle times – more connectable actuators.	The extensive CODESYS function library provides diagnostics and condition monitoring options.	For standardised pre-processing: reduces installation costs as an intelligent remote I/O terminal to IP65/IP67 directly at the machine.	CPX-CEC is ideally adapted to CPX and motion applications with up to 31 axes.
Compatibility with almost all control systems on the market is ensured via the CPX terminal.			
Simple, yet efficient: decentralised structures		The only one in the world to IP65	
The modular I/O system with up to 512 I/Os and CAN master functionality (CPX-CEC) offers complete flexibility, whether for open-loop or closed-	loop control. Stand-alone for low-cost automation of manual workstations, for example, or remote control with pre-processing.	The fully integrated automation platform for standard, proportional and servopneumatic, sensor and motion control to IP65.	Included: simple commissioning.

Classification of CPX-CEC in the portfolio for multi-axis controllers for electric drive technology			
Embedded controller		Modular controller	
CPX-CEC permits the flexible connection of valve actuators and electric drives on the terminal - programmable in CODESYS and can, if necessary, be	directly installed at the machine to IP65. The ideal complement to the gateway module CPX-CM-HPP.	The modular controllers complete the upper end of the range for actuating electric drives. The CECX-X-C1 is the ideal expansion option for a control cabinet in combination with electric drive technology and general control technology. The CECX-X-M1 executes advanced	tasks such as cam disks, multi-axis function modules to PLCopen and simple NC functions up to 2.5D. The robotic controller CMXR provides interpolating control for different kinematic systems (e.g. parallel kinematic system) with up to six axes.

CPX-CEC in the world of electric drive technology

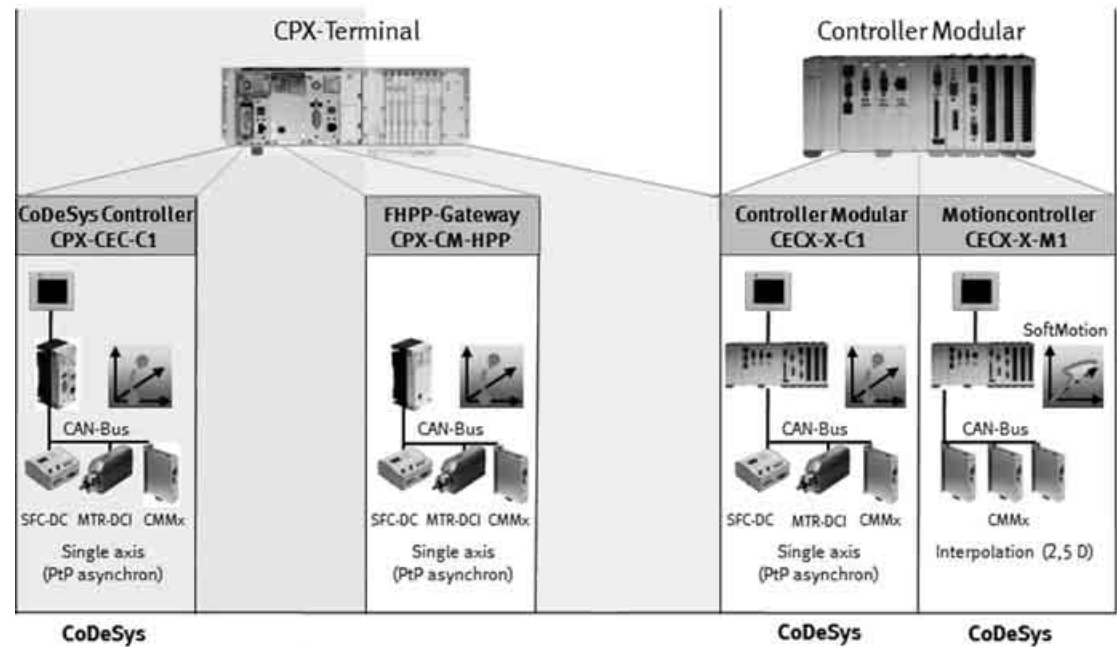

Control blocks CPX-CEC

Type codes

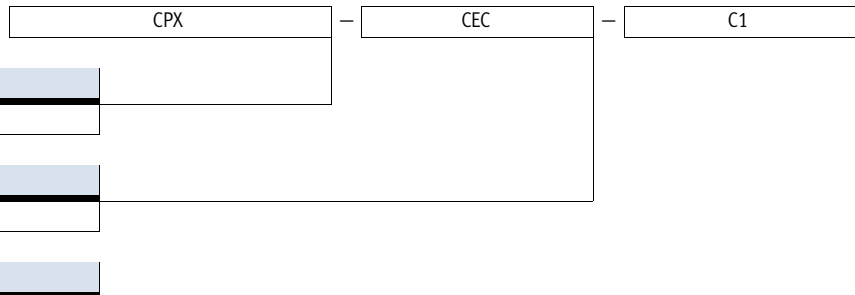

Type	
CPX	Modular electrical terminal
Electrical control	
CEC	Control block
Interface and function	
C1	CANopen
-	RS232

Control blocks CPX-CEC

Technical data

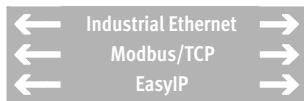

IT services:



The CODESYS controller is a modern control system for CPX terminals that enables programming with CODESYS to IEC 61131-3.

The power supply to and communication with other modules takes place via the interlinking block.

In addition to network connections, LEDs are also provided for the bus status, operating status of the PLC and CPX peripherals information, as are switching elements and a diagnostic interface for CPX-MMI and CPX-FMT.

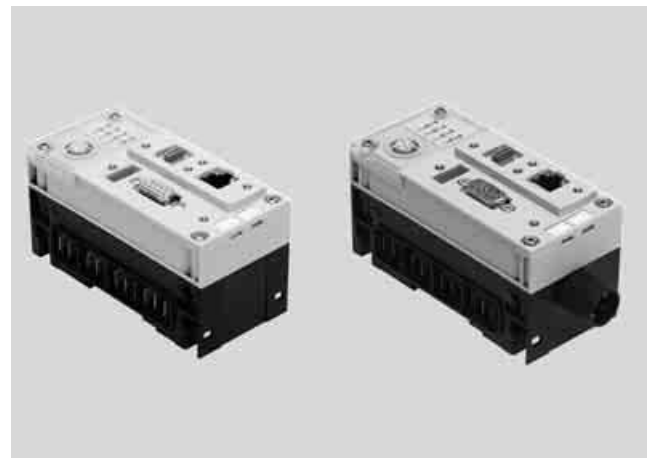

Application			
Bus connection		Communication protocols	Operating modes
The CPX-CEC is a remote controller that can be connected to a master PLC via the fieldbus nodes of the CPX terminal or via Ethernet. At the same	time, it is possible to operate the CPX-CEC as a compact stand-alone controller directly on the machine.	<ul style="list-style-type: none"> • Fieldbus via CPX bus nodes • Modbus/TCP • EasyIP 	<ul style="list-style-type: none"> • Stand-alone • Remote controller, fieldbus • Remote controller, Ethernet
Setting options			
The CPX-CEC has the following interfaces for monitoring, programming and commissioning:	<ul style="list-style-type: none"> • For the CPX-MMI/-FMT • Ethernet interface for IT applications • Remote diagnostics 	The operating mode and fieldbus protocol are set using the DIL switch on the CPX-CEC.	The integrated web server offers a convenient means of querying data saved in the CPX-CEC.
Features			
<ul style="list-style-type: none"> • Easy actuation of valve terminal configurations with MPA, VTSA • Diagnostics with flexible monitoring options for pressure, flow rate, cylinder operating time, air consumption 	<ul style="list-style-type: none"> • Actuation of decentralised installation systems based on CPI actuation of applications in proportional pneumatics • AS-Interface actuation via gateway 	<ul style="list-style-type: none"> • Connection to all fieldbuses as a remote controller and for pre-processing • Actuation of electric drives as individual axes via CANopen (CPX-CEC-C1) 	<ul style="list-style-type: none"> • Early warnings and visualisation options • Closed-loop pneumatic applications

Control blocks CPX-CEC

Technical data

General technical data		
Protocol	CODESYS Level 2	
	EasyIP	
	Modbus TCP	
	TCP/IP	
Processing time	Approx. 200 µs/1 k instruction	
Programming software	CODESYS provided by Festo V2.3	
Programming language	To IEC 61131-3	
	Sequential function chart (SFC)	
	Instruction list (IL)	
	Function chart (FCH), additional continuous function chart (CFC)	
	Ladder diagram (LD)	
Programming	Operating language	German, English
	Support for file handling	Yes
Device-specific diagnostics	Diagnostic memory	
	Channel and module-oriented diagnostics	
	Undervoltage/short circuit of modules	
LED displays	Bus-specific	TP: Link/traffic
	Product-specific	RUN: PLC status
		STOP: PLC status
		ERR: PLC runtime error
		PS: Electronics supply, sensor supply
		PL: Load supply
		SF: System fault
M: Modify/forcing active		
IP address setting	DHCP	
	Via CODESYS	
	Via MMI	
Function blocks	CPX diagnostic status, copy CPX diagnostic trace, read CPX module diagnostics, etc.	
Product weight	[g]	155
Dimensions (incl. interlinking block) W x L x H	[mm]	50 x 107 x 55

Materials		
Housing	Reinforced PA	
	PC	
Note on materials	RoHS-compliant	

Operating and environmental conditions		
Ambient temperature	[°C]	-5 ... +50
Storage temperature	[°C]	-20 ... +70
Relative air humidity	[%]	95, non-condensing
Corrosion resistance class CRC ¹⁾		2

1) Corrosion resistance class CRC 2 to Festo standard FN 940070
Moderate corrosion stress. Indoor applications in which condensation may occur. External visible parts with primarily decorative requirements for the surface and which are in direct contact with the ambient atmosphere typical for industrial applications.

Control blocks CPX-CEC

Technical data

Electrical data			
Nominal operating voltage		[V DC]	24
Load voltage	Nominal operating voltage	[V DC]	24
	With pneumatics type VTSA	[V DC]	21.6 ... 26.4
	With pneumatics type MPA	[V DC]	18 ... 30
	Without pneumatics	[V DC]	18 ... 30
Power failure buffering		[ms]	10
Intrinsic current consumption at nominal operating voltage		[mA]	Typically 85
Degree of protection to EN 60529			IP65, IP67

Technical data				
Type			CPX-CEC	CPX-CEC-C1
Additional functions			RS232 communication function	Motion functions for electric drives
CPU data	Flash	[MB]	32	32
	RAM	[MB]	32	32
	Processor	[MHz]	400	400
Control interface			–	CAN bus
Parameterisation			CODESYS V2.3	
Configuration support			CODESYS V2.3	
Program memory, user program		[MB]	4	
Flags			CODESYS variable concept	
	Remanent data	[kB]	30	30
	Global data memory	[MB]	8	8
Control elements			–	DIL switch for CAN termination
			Rotary switch for RUN/STOP	Rotary switch for RUN/STOP
Total number of axes			–	31
Ethernet	Number		1	
	Connection technology		RJ45 socket, 8-pin	
	Data transmission speed	[Mbps]	10/100	
	Supported protocols		TCP/IP, EasyIP, Modbus TCP	
Fieldbus interface	Number		–	1
	Connection technology		–	Sub-D plug connector, 9-pin
	Data transmission speed, can be set via software	[kbps]	–	125, 250, 500, 800, 1000
	Supported protocols		–	CAN bus
	Galvanic isolation		–	Yes
Data interface	Number		1	
	Connection technology		Sub-D socket, 9-pin	
	Data transmission speed, can be set via software	[kbps]	9.6 ... 230.4	
	Supported protocols		RS232 interface	
	Galvanic isolation		Yes	

Control blocks CPX-CEC

Technical data

Connection and display components CPX-CEC-C1

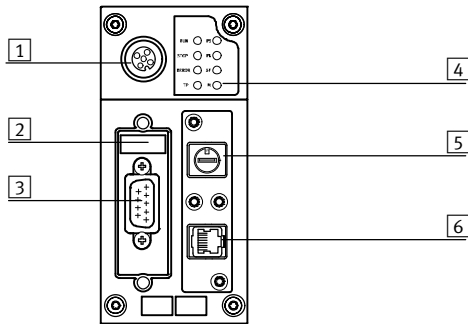

- 1 CPX-MMI connection
- 2 DIL switch
- 3 Fieldbus interface
(Sub-D plug connector, 9-pin)
- 4 Status LEDs, bus-specific and product-specific
- 5 RUN/STOP rotary switch
- 6 Ethernet interface (RJ45 socket, 8-pin)

Pin allocation – CPX-CEC-C1

	Pin	Signal	Meaning
Fieldbus interface, Sub-D plug connector			
	1	n.c.	Not connected
	2	CAN_L	CAN low
	3	CAN_GND	CAN ground
	4	n.c.	Not connected
	5	CAN_SHLD	Connection to functional earth FE
	6	CAN_GND	CAN ground (optional) ¹⁾
	7	CAN_H	CAN high
	8	n.c.	Not connected
	9	n.c.	Not connected
	Housing	Screening	Plug connector housing must be connected to FE
Ethernet interface, RJ45 plug connector			
	1	TD+	Transmitted data+
	2	TD-	Transmitted data-
	3	RD+	Received data+
	4	n.c.	Not connected
	5	n.c.	Not connected
	6	RD-	Received data-
	7	n.c.	Not connected
	8	n.c.	Not connected
Housing	Screening	Screening	

1) If a drive controller with external power supply is connected, CAN ground (optional), pin 6, on the CPX-CEC-C1, CPX-CEC-M1 must not be used.

Control blocks CPX-CEC

Technical data

Connection and display components CPX-CEC

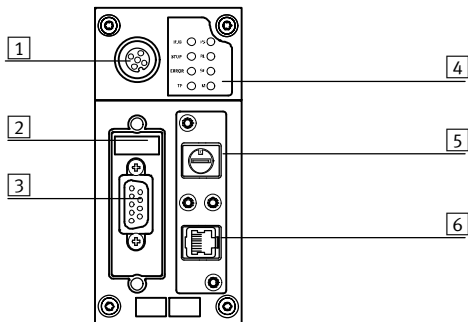

- 1 CPX-MMI connection
- 2 DIL switch
- 3 RS232 interface
(Sub-D socket, 9-pin)
- 4 Status LEDs, bus-specific and
product-specific
- 5 RUN/STOP rotary switch
- 6 Ethernet interface (RJ45 socket,
8-pin)







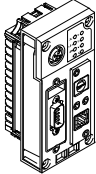
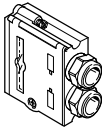
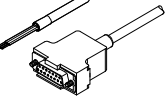
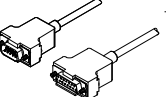

Pin allocation – CPX-CEC

	Pin	Signal	Meaning
RS232 interface, Sub-D socket			
	1	n.c.	Not connected
	2	RXD	Received data
	3	TXD	Transmitted data
	4	n.c.	Not connected
	5	GND	Data reference potential
	6	n.c.	Not connected
	7	n.c.	Not connected
	8	n.c.	Not connected
	9	n.c.	Not connected
	Screening	Screening	Connection to functional earth
Ethernet interface, RJ45 plug connector			
	1	TD+	Transmitted data+
	2	TD-	Transmitted data-
	3	RD+	Received data+
	4	n.c.	Not connected
	5	n.c.	Not connected
	6	RD-	Received data-
	7	n.c.	Not connected
	8	n.c.	Not connected
Housing	Screening	Screening	

Control blocks CPX-CEC

Accessories



Ordering data			
Designation		Part No.	Type
Control block			
	Motion functions for electric drives	567347	CPX-CEC-C1
	RS232 communication function	567346	CPX-CEC
Fieldbus interface			
	Sub-D plug connector, 9-pin, for CANopen	532219	FBS-SUB-9-BU-2x5POL-B
	Connecting cable for RS232 interface	539642	FEC-KBG7
	Connecting cable for RS232 interface	539643	FEC-KBG8
	Micro Style bus connection, 2xM12 for DeviceNet/CANopen	525632	FBA-2-M12-5POL
	Socket for Micro Style connection, M12	18324	FBSD-GD-9-5POL
	Plug connector for Micro Style connection, M12	175380	FBS-M12-5GS-PG9
	Open Style bus connection for 5-pin terminal strip for DeviceNet/CANopen	525634	FBA-1-SL-5POL
	Terminal strip for Open Style connection, 5-pin	525635	FBSD-KL-2x5POL
Ethernet interface			
	RJ45 plug connector	534494	FBS-RJ45-8-GS
	Cover for RJ45 connection	534496	AK-Rj45

Control blocks CPX-CEC

Accessories

FESTO

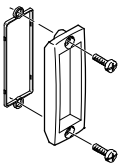
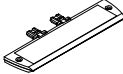
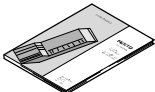
Ordering data			
Designation		Part No.	Type
Covers and attachments			
	Inspection cover, transparent, for Sub-D connection	533334	AK-SUB-9/15-B
	Inscription label holder for manifold block	536593	CPX-ST-1
User documentation			
	Manual for control block CPX-CEC	German	569121 P.BE-CPX-CEC-DE
		English	569122 P.BE-CPX-CEC-EN

Festo North America

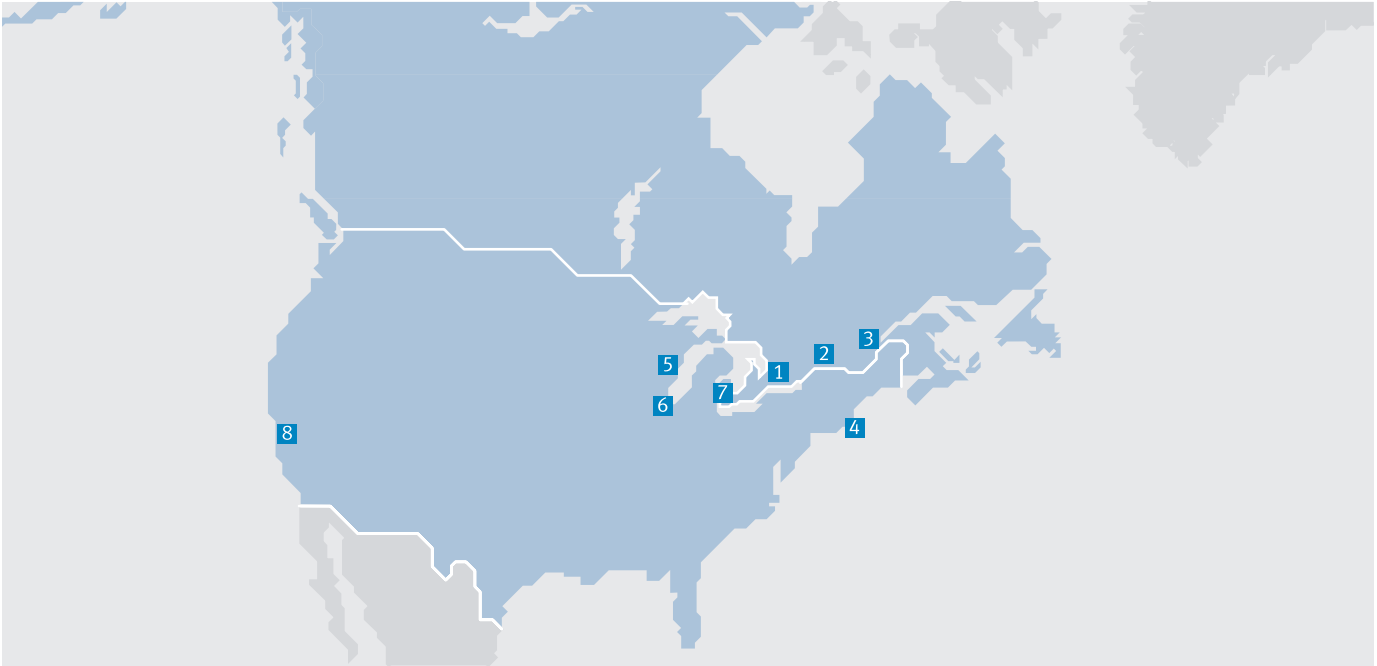

**1 Festo Canada
Headquarters
Festo Inc.**
5300 Explorer Drive
Mississauga, ON
L4W 5G4

2 Montréal
5600, Trans-Canada
Pointe-Claire, QC
H9R 1B6

3 Québec City
2930, rue Watt#117
Québec, QC
G1X 4G3



**4 Festo United States
Headquarters
Festo Corporation**
395 Moreland Road
Hauppauge, NY
11788

5 Appleton
North 922 Tower View Drive, Suite N
Greenville, WI
54942

7 Detroit
1441 West Long Lake Road
Troy, MI
48098

6 Chicago
85 W Algonquin - Suite 340
Arlington Heights, IL
60005

8 Silicon Valley
4935 Southfront Road, Suite F
Livermore, CA
94550

Festo Regional Contact Center

Canadian Customers

Commercial Support:
Tel: 1 877 GO FESTO (1 877 463 3786)
Fax: 1 877 FX FESTO (1 877 393 3786)
Email: festo.canada@ca.festo.com

Technical Support:
Tel: 1 866 GO FESTO (1 866 463 3786)
Fax: 1 877 FX FESTO (1 877 393 3786)
Email: technical.support@ca.festo.com

USA Customers

Commercial Support:
Tel: 1 800 99 FESTO (1 800 993 3786)
Fax: 1 800 96 FESTO (1 800 963 3786)
Email: customer.service@us.festo.com

Technical Support:
Tel: 1 866 GO FESTO (1 866 463 3786)
Fax: 1 800 96 FESTO (1 800 963 3786)
Email: product.support@us.festo.com

Subject to change

Internet: www.festo.com/us